

## Schottky Barrier Rectifier

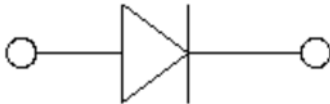

### Features

- Moisture sensitivity level 1
- Reverse voltage: 20V/30V/40V
- Average forward current : 1A

### Application

- High frequency and low voltage rectifier

### Mechanical data

- **Package:** SOD-323
- **Terminals:** Tin plated leads, solderable per J-STD-002 and JESD22-B102

### ■ Maximum Ratings (T<sub>a</sub>=25°C Unless otherwise specified)

Parameter	Symbol	Unit	Value	
Device marking code			B5817WS	SJ
			B5818WS	SK
			B5819WS	SL
Repetitive peak reverse voltage	V <sub>RRM</sub>	V	B5817WS	20
			B5818WS	30
			B5819WS	40
Forward current	I <sub>F</sub>	A	1	
Non-repetitive surge peak forward current @ t=8.3ms half-sine wave	I <sub>FSM</sub>	A	10	
Non-repetitive surge peak forward current @ t=1ms square wave			15	



## B5817WS THRU B5819WS

RoHS  
COMPLIANT

Parameter	Symbol	Unit	Value
Power dissipation	$P_D$	mW	200
Junction temperature	$T_J$	°C	-65 to +125
Storage temperature	$T_{STG}$	°C	-65 to +150

### ■ Electrical Characteristics (T<sub>a</sub>=25°C Unless otherwise specified)

Parameter	Symbol	Unit	Conditions	Min	Typ	Max	
Reverse voltage	$V_R$	V	B5817WS	$I_R=1mA$	20		
			B5818WS		30		
			B5819WS		40		
Forward voltage	$V_{F1}$	V	B5817WS	$I_F=1A$			0.45
			B5818WS				0.55
			B5819WS				0.60
	$V_{F2}$	V	B5817WS	$I_F=3A$			0.75
			B5818WS				0.875
			B5819WS				0.90
Reverse leakage current	$I_R$	uA	B5817WS	$V_R=20V$			200
			B5818WS	$V_R=30V$			40
			B5819WS	$V_R=40V$			40
Junction capacitance	$C_j$	pF	$V_R=4V, f=1MHz$			120	



## ■ Thermal Characteristics

Parameter	Symbol	Unit	Value
Thermal resistance, junction-to-ambient	$R_{\theta J-A}^{(1)}$	$^{\circ}\text{C}/\text{W}$	500
Thermal resistance, junction-to-case	$R_{\theta J-C}^{(1)}$	$^{\circ}\text{C}/\text{W}$	400

### Note:

(1) Thermal resistance from junction to ambient and from junction to case mounted on P.C.B. with 8mm\*9mm copper pad areas

## ■ Characteristics

### B5817WS

Fig 1:  $P_D$ - $T_a$  Curve

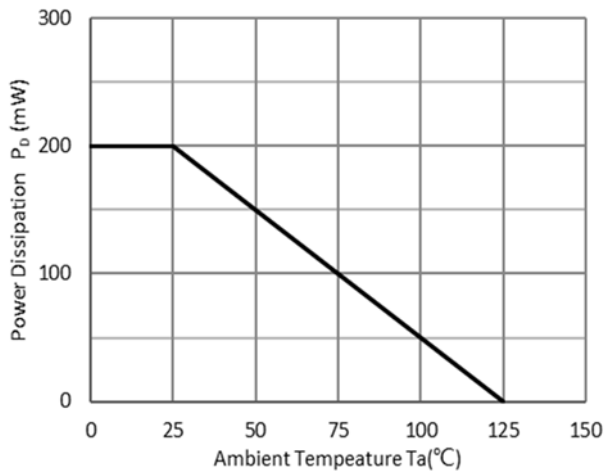

Fig 2: Capacitance Capability

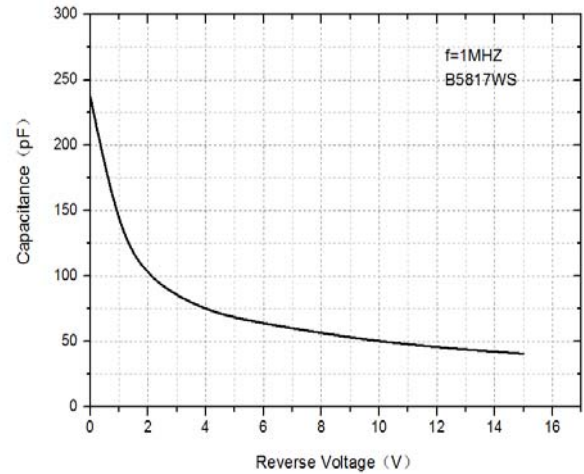

Fig 3: Typical Forward Characteristics

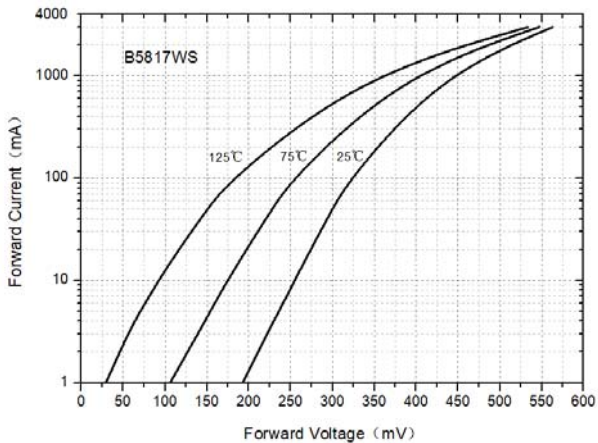
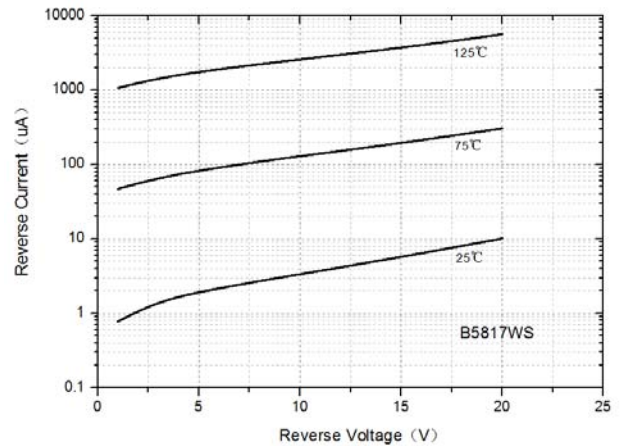

Fig 4: Typical Reverse Characteristics





# B5817WS THRU B5819WS

RoHS  
COMPLIANT

## B5818WS & B5819WS

**Fig 1: P<sub>D</sub>-T<sub>a</sub> Curve**

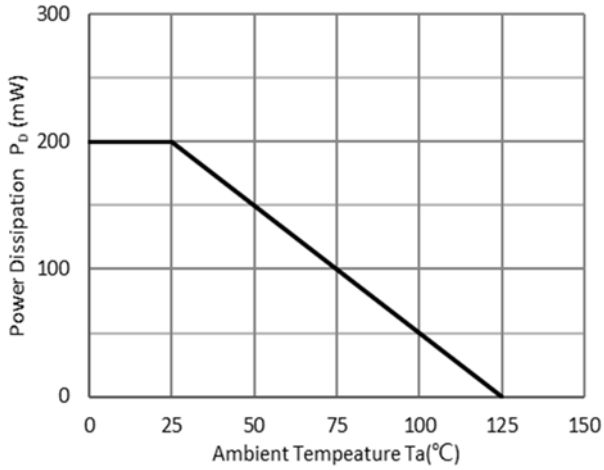

**Fig 2: Capacitance Capability**

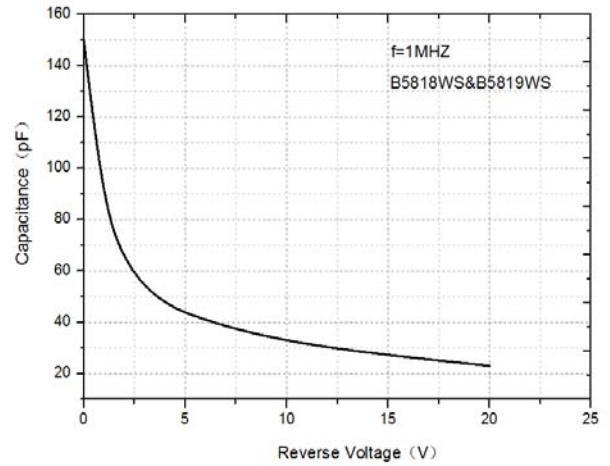

**Fig 3: Typical Forward Characteristics**

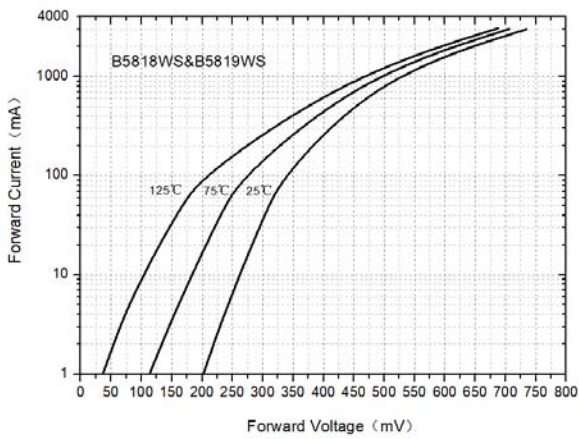

**Fig 4: Typical Reverse Characteristics**

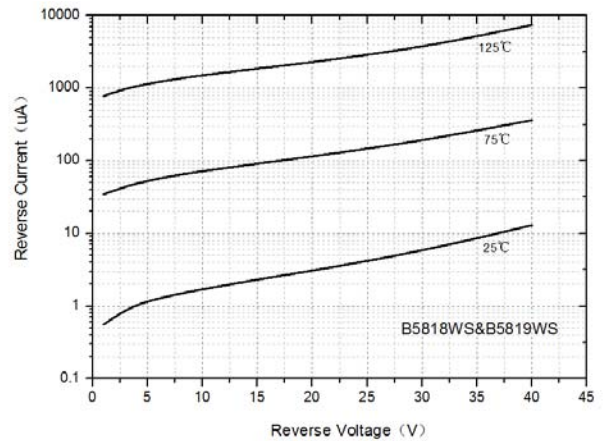



# B5817WS THRU B5819WS

RoHS  
COMPLIANT

## ■ Ordering Information

Preferred P/N	Packing code	Unit weight(g)	Minimum package(pcs)	Inner box quantity(pcs)	Outer carton quantity(pcs)	Delivery mode
B5817WS THRU B5819WS	F2	Approximate 0.0048	3000	30000	120000	7" reel
B5817WS THRU B5819WS	F3	Approximate 0.0048	10000	/	210000	13" reel

## ■ Outline Dimensions

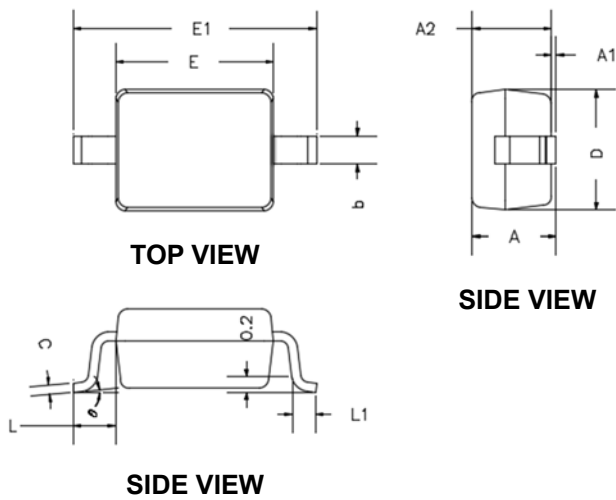

DIMENSIONS				
DIM	INCHES		MM	
	MIN	MAX	MIN	MAX
A	---	0.0393	---	1.0000
A1	0.0000	0.0039	0.0000	0.1000
A2	0.0314	0.0354	0.8000	0.9000
b	0.0098	0.0157	0.2500	0.4000
c	0.0031	0.0059	0.0800	0.1500
D	0.0472	0.0551	1.2000	1.4000
E	0.0629	0.0709	1.6000	1.8000
E1	0.0984	0.1063	2.5000	2.7000
L	0.0187TYP		0.475TYP	
L1	0.0098	0.0157	0.250	0.400
e	0°	8°	0°	8°

## ■ Suggested Pad Layout

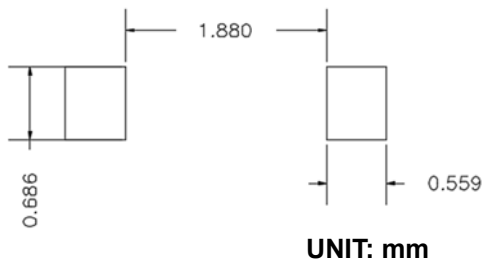



## Disclaimer

The information presented in this document is for reference only. Yangzhou Yangjie Electronic Technology Co., Ltd. reserves the right to make changes without notice for the specification of the products displayed herein to improve reliability, function, or design or otherwise.

The product listed herein is designed to be used with ordinary electronic equipment or devices, and not designed to be used with equipment or devices which require high level of reliability and the malfunction of which would directly endanger human life (such as medical instruments, transportation equipment, aerospace machinery, nuclear-reactor controllers, fuel controllers and other safety devices), Yangjie or anyone on its behalf, assumes no responsibility or liability for any damages resulting from such improper use of sale.

This publication supersedes & replaces all information previously supplied. For additional information, please visit our website [http:// www.21yangjie.com](http://www.21yangjie.com) , or consult your nearest Yangjie's sales office for further assistance.